

Model : Aum-1000NA for general use

Wiring diagram for Heater or Cooler & Alarm mode

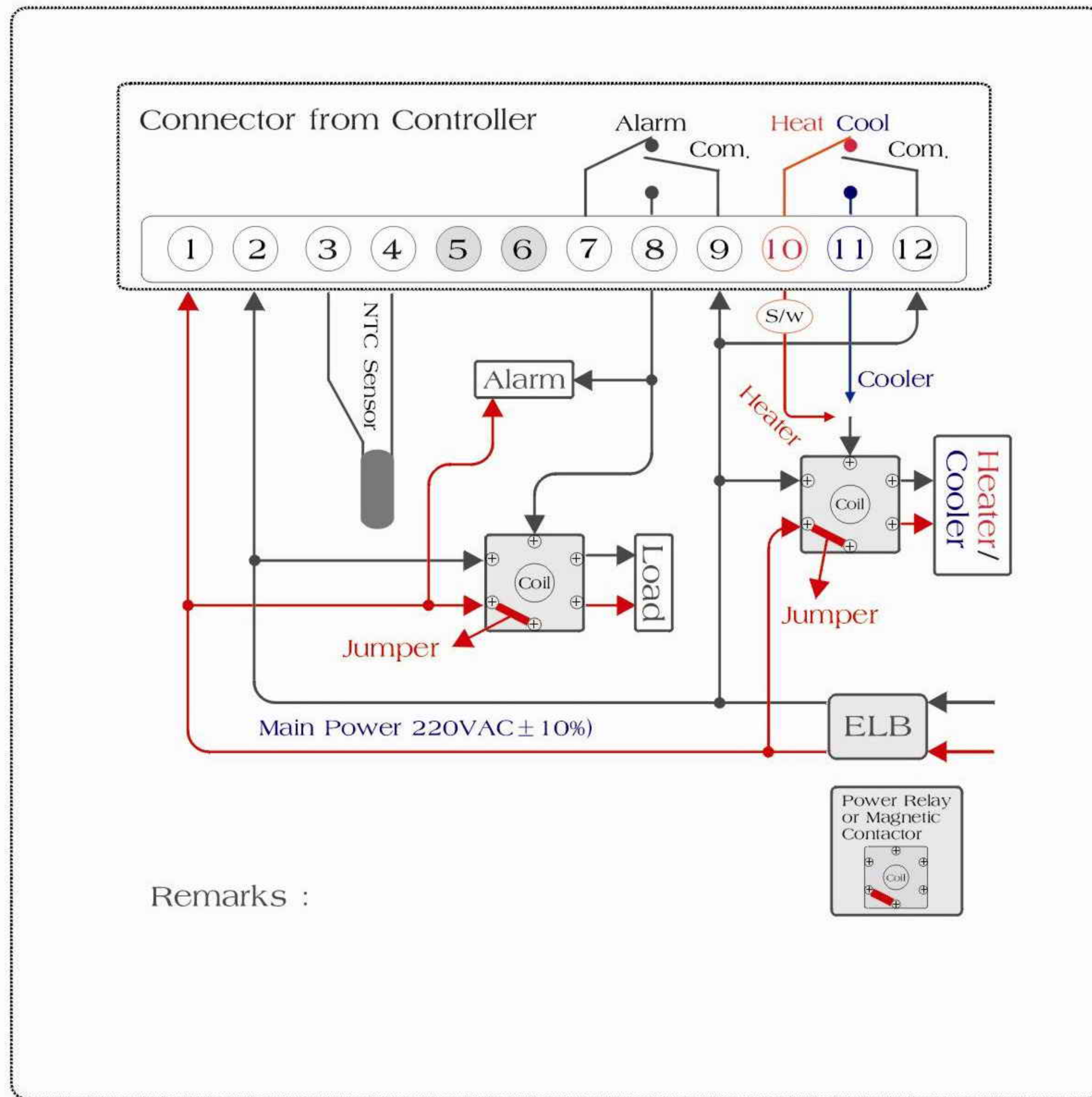

Remarks :

**Caution in use**

1. Avoid an excessive temperature, humidity and shock.
2. Keep the instrument off strong acid, oil, dust and direct sunlight.
3. Keep the instrument away from the high voltage of a generator or a motor.
4. Let the end part of a sensor stay toward the top in order to prevent the droplet of water.
5. In case of resumption of the electrical power, it is recommended to be switched on after 5seconds to avoid an electrical fault.

Mod.: Aum-1000NA



" Digital Temperature Controller "

Mod. : Aum-1000NA

----- Operating Manual -----



1. Either a heating function or a cooling function can be chosen. The set value of a low limit and a high limit for the function of the working range of a selection values. And therefore, The set values exceed the conditioned range, the signal of the lamp starts warning so that any possible damage or accident can be prevented in advance. Especially it is reliable performance is based on a system of the feed back, which always sorts out, and inspects the results of it is performing values. Accordingly it can precisely detect and display the figures up to one decimal place. It is working range that can be covered is from  $-40.0^{\circ}\text{C}$  to  $100.0^{\circ}\text{C}$ .
2. There are functions such as S.V.(The selection value), DIF.(Differential), T.D.(The time delay), CA.(Calibration). In addition, the function of the "High" limit and the "Low" limit can also be an optional extra within selection value.
3. It is composed of a main body, a sensor(NTC 5.0Kohm at  $25.0^{\circ}\text{C}$ ) and a transformer. The power supply is 220VAC. The sensor does not require any certain direction. As soon as the power and a sensor is switched on, the temperature that has been detected by the sensor will be shown on the window.

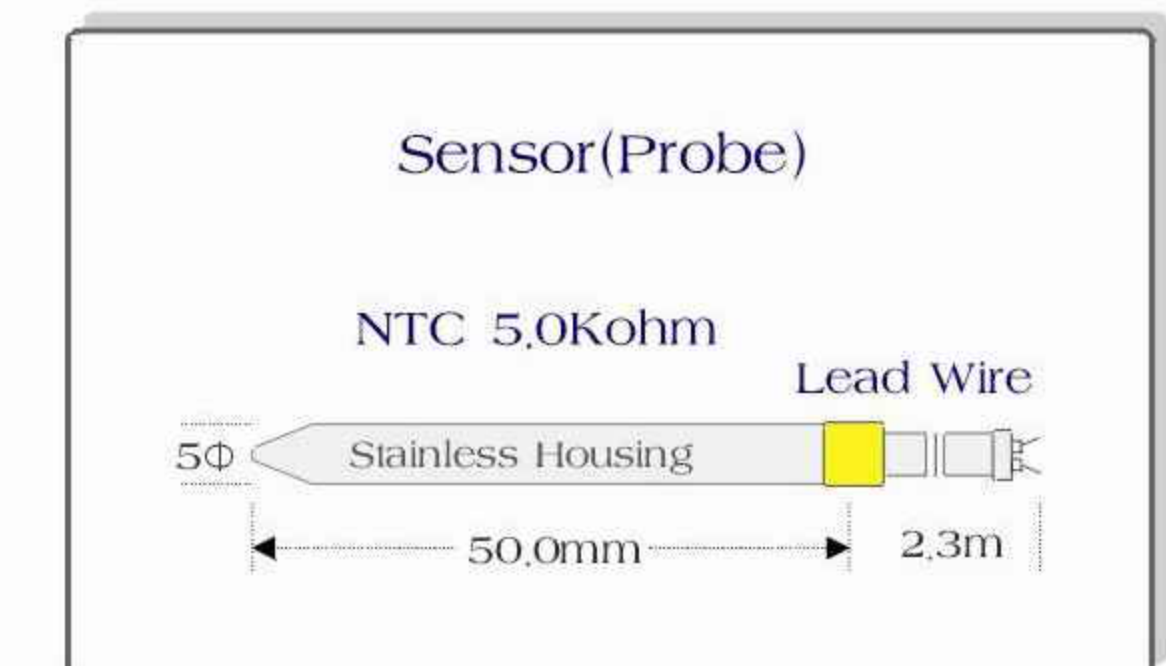
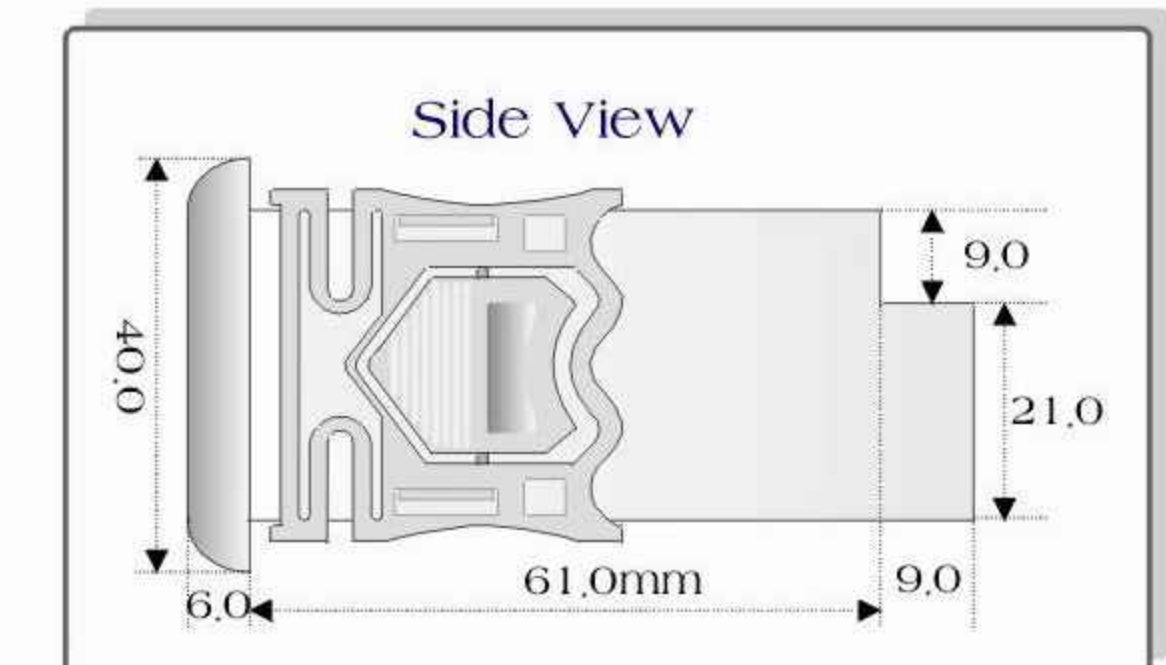
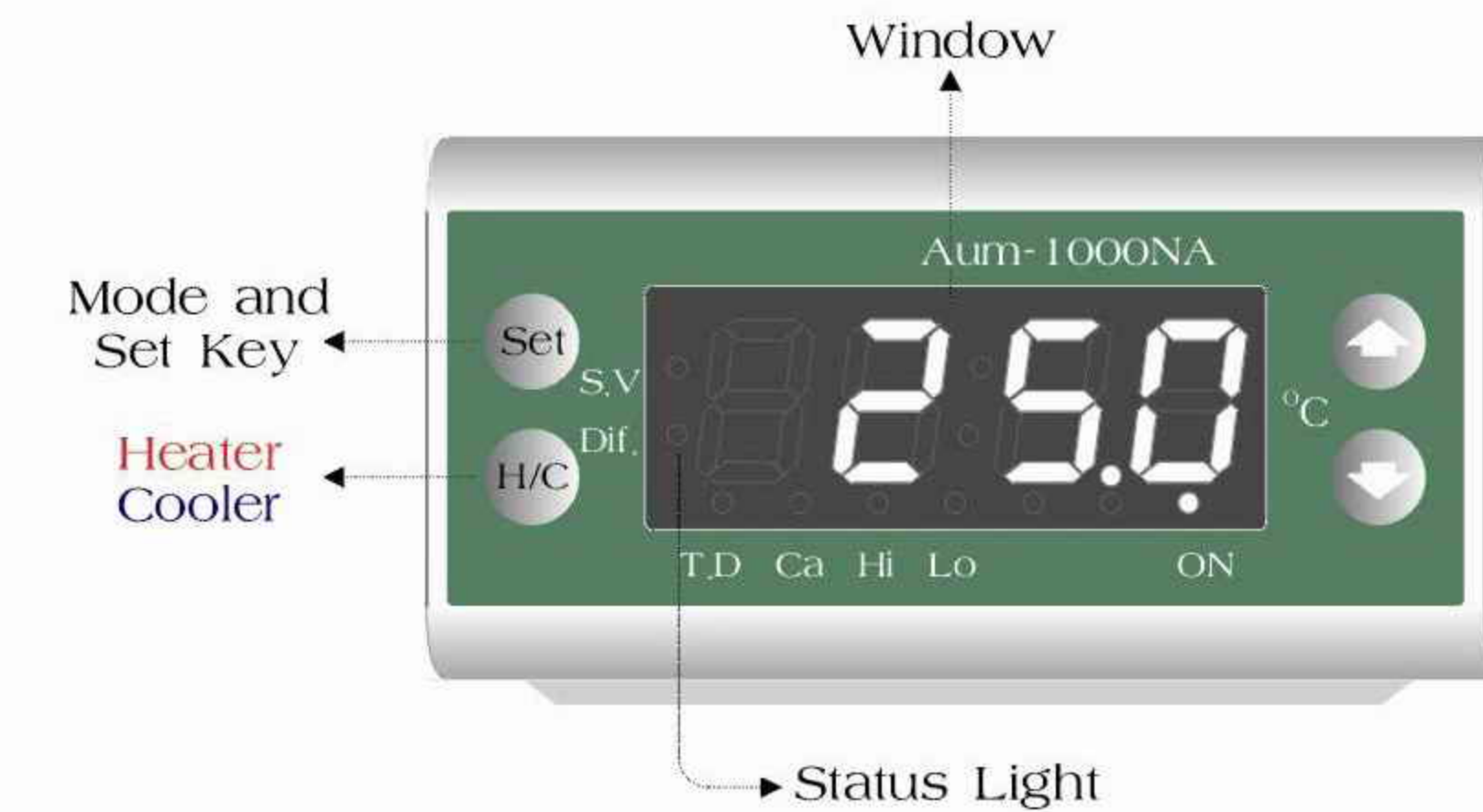

Drilling Template : B:70,5xH:29,5mm

## Method of Program loading

Mod. : Aum-1000NA

1. Selection Value : Check the S.V. lamp

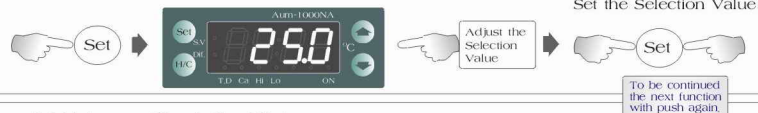

2. Differential Value : Check the Dif. lamp



3. Time Delay : Check the T.D. lamp



4. Calibration : Check the CA. lamp



5. High Limit & Alarm : Check the Hi. lamp



6. Low Limit & Alarm : Check the Lo. lamp

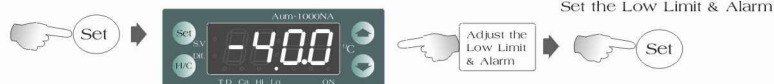

7. Alarm Signal : Check the flag "AL:AL" or "AL:FL"

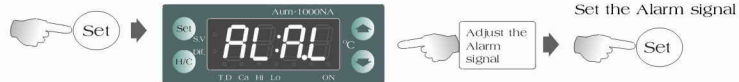

9. Operating Lamp : Check the Relay ON/OFF



### The heating or cooling cycle in process

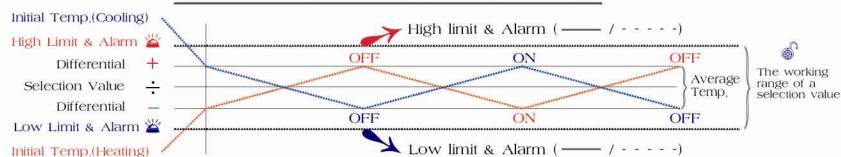

Reference: 1. There are two ways that are optional with regard to the function of alarm. One is the signal of alert (ALarm : Alert ———), and the other is the signal of flash (ALarm : FLASH - - - - -).  
2. After all the power lines have completely been connected, the power must be switched on.

Mod. : Aum-1000NA

- The Aum-1000NA requires the power supply of 220VAC. And the sensor has been switched on, the actual temperature that the sensor detected will be shown on the window.
- Whenever the "Set" key is pressed, the next function will be chosen. But the function of T.D.(The time delay) needs to be pressed the "Set" key and the "H/C" key at the same time.
- After a function is selected by the "Set" key, adjust a required value of a direct parameter with the "▲" or the "▼" one. And then the "Set" key must be pressed again to finalize the new setting that has just been set by the "▲" key and the "▼" one. In case, the completion with the "Set" key at the end of a function failed, the previous setting before the correction will be continued to fulfill it is duty.
- Once a function has been chosen, press the "▲" key or the "▼" key to correct the value of a direct parameter while the status light is blinking.
- Although either a function has been selected, or a correction has been completed by the "Set" key, there is no slight alteration at all. After 20 seconds, the mode will automatically be returned to a position that the present temperature is shown on the window.
- Press the "▲" key while the "H/C" key is being pressed and then, the "Heat" will be shown on the window. On the contrary, press the "▼" key to select the cooling functioning mode with the "Cool" on the window. One of the modes is consistent with the linked machine, the light for the "ON" will be lit.
- In case, the values of a direct parameter are desired to be scrolled up, or down swiftly. Keep on pressing the "▲" key or the "▼" one.

No.	Status Light	Mode	Working Range	Initial Settings	Unit	Apply	Definition
1.	①	S.V.	-40.0~100.0	25.0	°C	Load	Load (Heater/Cooler) S.V. : Selection Value

- A function has been selected by the "Set" key, and press the "▲" key or the "▼" one to correct the previous setting. The "Set" key must be pressed to finalize a new setting that has just been corrected thereafter.
- The range of selected value is as follows :  $-40.0^{\circ}\text{C} < (\text{S.V.}) + (\text{Dif.}) + (\text{Ca.}) < 100.0^{\circ}\text{C}$ .

2.	②	Dif.	$\pm(0.1\sim 12.7)$	$\pm(0.5)$	°C	S.V.	Dif. : Differential(Hysteresis)
----	---	------	---------------------	------------	----	------	---------------------------------

- The set value of the Dif, simultaneously applies to both values, which can be sum up with by such a formula of  $(\text{S.V.}) \pm (\text{Dif.})$ . For instance, if the selection value is  $25.0^{\circ}\text{C}$  and the set value of Dif, is  $0.5^{\circ}\text{C}$ , the working range of temperature will be within  $24.5\sim 25.5^{\circ}\text{C}$ .
- At least 0.3 is recommended to protect the mechanical system from an excessive operation.

3.	③	T.D.	00:00~15:00	00:03	minute/second	Load	Load (Heater/Cooler) T. D. : Time delay
----	---	------	-------------	-------	---------------	------	--

- From the moment when the relay stops working until the set value of the T.D, has run out, no function related to the relay will be working. Although other conditions compel continuous performance. But the relay works after a complete function of the T.D.. This function protects machines from the damage that can be resulted in due to the frequent stops and resumptions.
- Press the "Set" key and the "H/C" key at the same time to select the function of the T.D..

4.	④	Ca.	+/-0.0~3.1	0.0	°C	Sensor	Ca. : Calibration
----	---	-----	------------	-----	----	--------	-------------------

- The purpose of this function is to calibrate the differences in present temperature that happens when the led wire of a sensor has been extended considerably.
- Keep the led(Shielded) wire of a sensor away from a powerful generator or an electrical noise.

5.	⑤	Hi	S.V.<99.9	99.0	°C	No.2 Relay	High : Alarm-High Limit
----	---	----	-----------	------	----	------------	-------------------------

- The present temperature exceeds the setting of a high limit for the function of the alarm, the No.2 relay, which is for the alarm starts functioning so that the status light of a high limit turns on.
- When the mode is ruling a cooling function, an auxiliary cooler is available.
- The new set values of the high limit, which can be selected, and finalized by the "Set" key strictly regulate the working range whose value of a direct parameter must be above the setting of a high limit and the selection value(S.V.) can not exceed the High limit(lock function).
- The signal of alarm seemingly recommends to check the linked machine(heater/cooler), which tends to be found wrong.

6.	⑥	Lo	-40.0<S.V.	-40.0	°C	No.2 Relay	Low : Alarm-Low Limit
----	---	----	------------	-------	----	------------	-----------------------

- The present temperature exceeds the setting of a low limit for the function of the alarm, the No.2 relay, which is for the alarm starts functioning so that the status light of a low limit turns on.
- When the mode is ruling a heating function, an auxiliary heater is available.
- The new set values of the low limit, which can be selected, and finalized by the "Set" key strictly regulate the working range whose value of a direct parameter must be below the setting of a low limit and the selection value(S.V.) can not exceed the low limit(lock function).
- The signal of alarm seemingly recommends to check the linked machine(heater/cooler), which tends to be found wrong.

7.	Flag	AL	AL: FL/AL	AL : AL	-	Alarm	Alarm : (AL:Alert), (FL:Flash)
----	------	----	-----------	---------	---	-------	--------------------------------

- There are two different signals with regard to the function of alarm. One is a state of "Alert", the other is a state of "Flash".
- The mode of the "AL:FL" is only applicable for a buzzer. The other mode of the "AL:AL" can only be applied to an auxiliary machine, which must be controlled by the main machine.
- Press the "▲" key to choose the "AL:FL". And also press the "▼" key to select the "AL:AL". Then, the "Set" key must be pressed to finalize a selection of a new setting.

8.	⑧	ON	-	-	-	Load	Load (Heater/Cooler)
----	---	----	---	---	---	------	----------------------

- Either a heater or a cooler is operating, the lamp is always switched on.