

Model : Aum-2KND for Refrigerator

Wiring diagram for "Cooling and Defrosting" mode

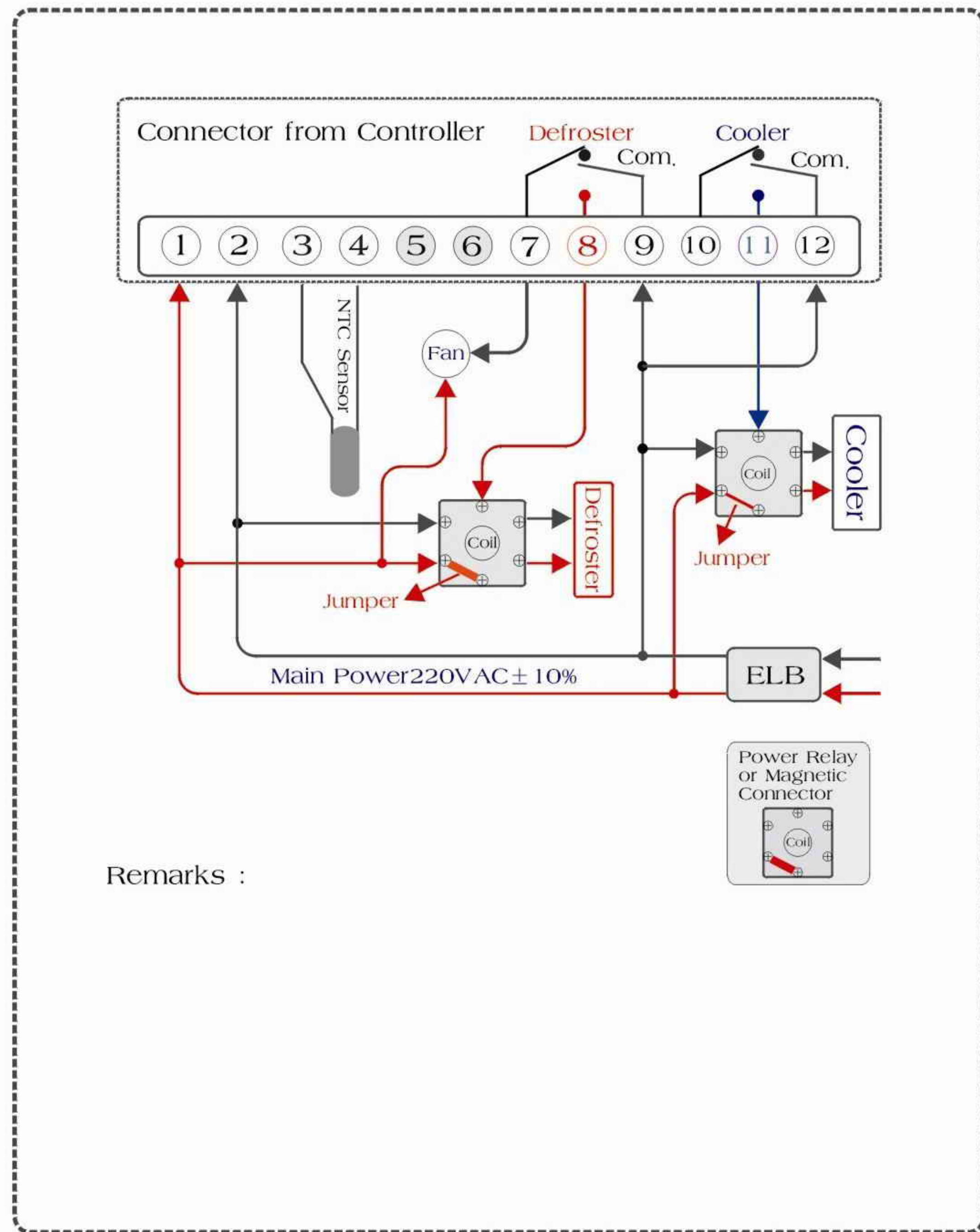

Digital Temperature Controller

----- Operating Manual -----

1. It is solely for refrigeration as a unit that Micro-Processor has been installed in to control a desirable temperature as well as a defrosting mode. Especially it is reliable performance is based on a system of the feed back, which always sorts out and inspects the results of it is system. Furthermore, this system also compares the selected set values with the resulted value of it is system in order to correct and perform automatically. And therefore, it can accurately detect, and show the figure up to one decimal place. It is range that can be covered is from -40.0 to 100.0°C .
2. There are functions such as S.V.(The value of selection), Dif. (Differential), Ca. (Calibration), T.D. (The time of delay), Int.(The interval of a defrosting cycle), DEF.(The completion of defrosting time), H/G (The method of defrosting by "Electric Heater" or "Hot Gas"), I/O (The Compressor IN or OUT).
3. Aum-2KND is conveniently designed for installing in panel. It consists of a main body, a transformer and a sensor. The available power supply is 12~15VAC/DC. And the sensor does not required any certain directions.

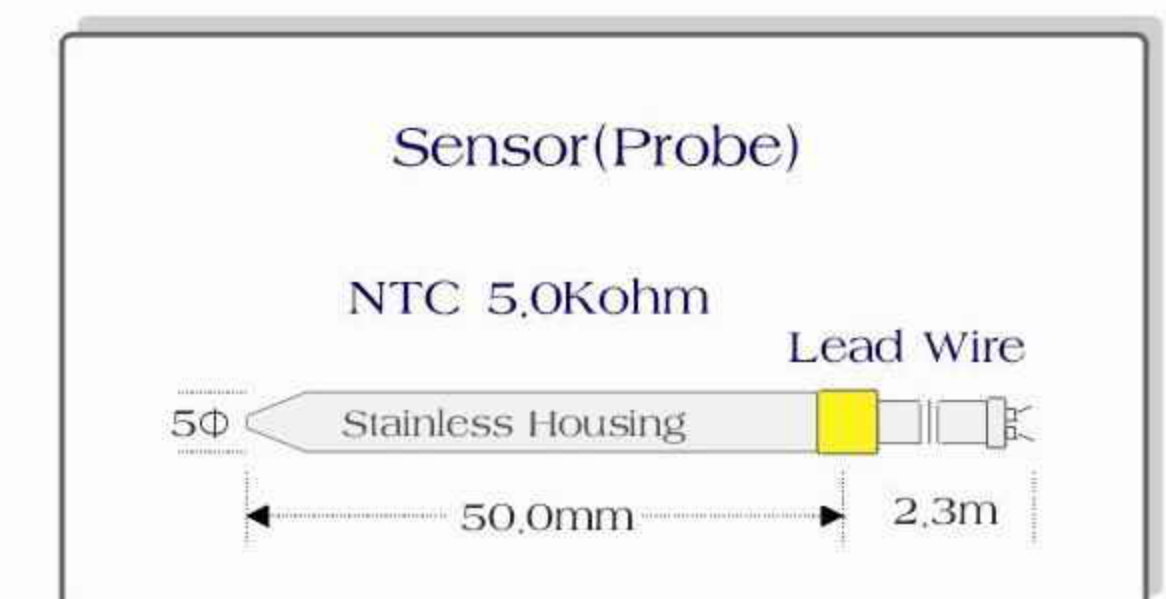
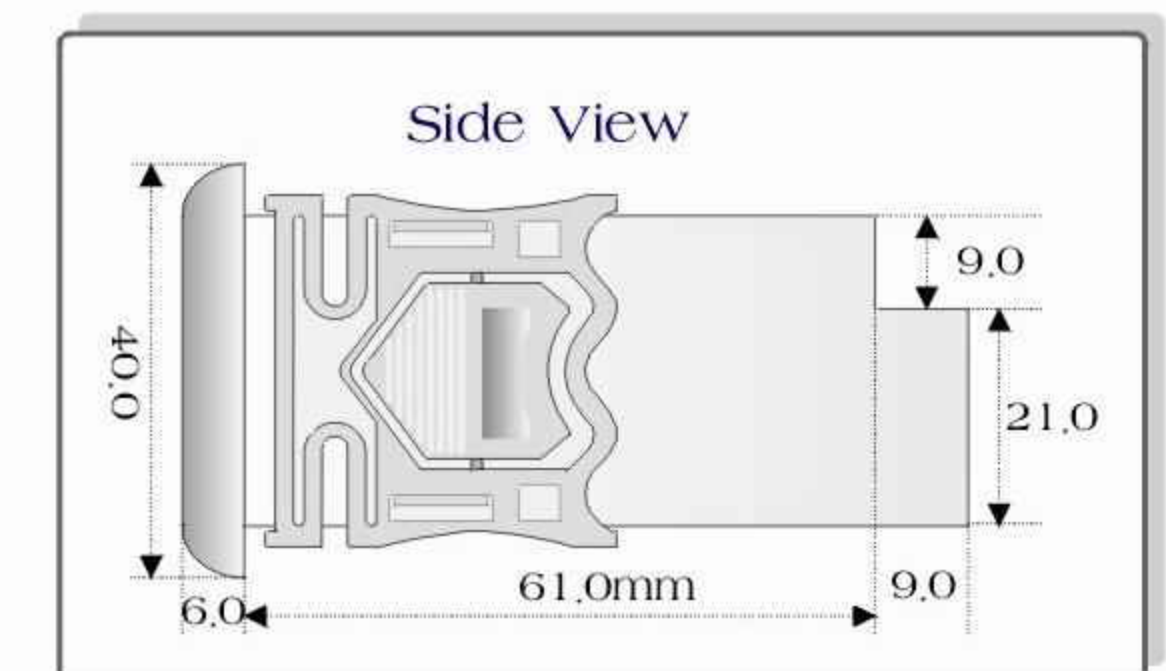
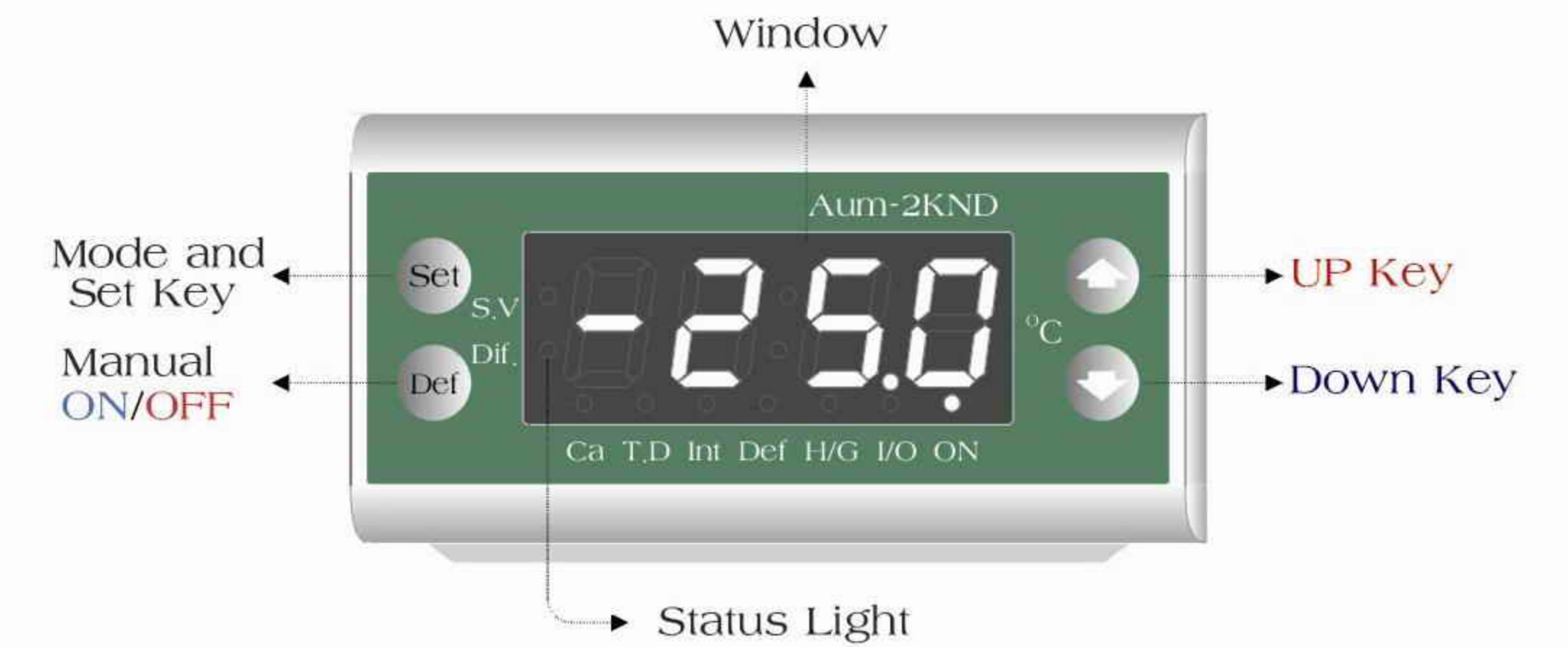

Drilling Template : B:70.5xH:29.5mm

Method of Program Loading

Mod. : Aum-2KND

1. Selection Value : Check the S.V. lamp

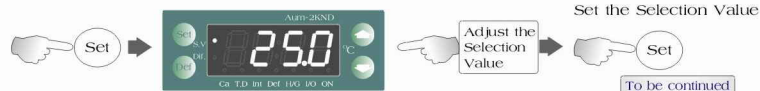

To be continued the next function with push again.

2. Differential : Check the Dif. lamp

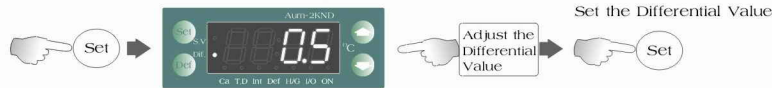

3. Calibration : Check the Ca. lamp



4. Time Delay : Check the T.D. lamp



5. Interval(Hour) : Check the Int. lamp

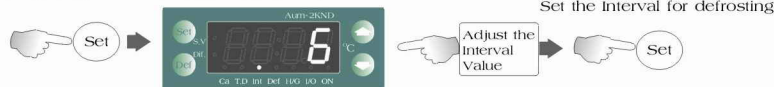

6. Defrost(by time) : Check the Def. lamp

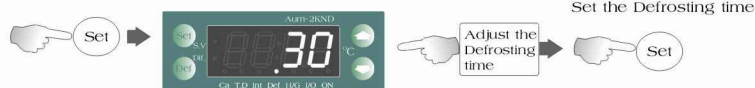

7. Heater/ Hot Gas : Check the H/G lamp

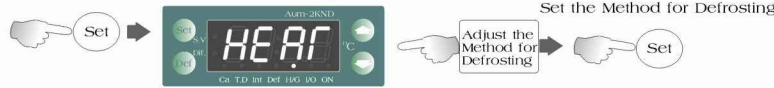

8. Fault of sensor : Check the I/O(in/out) lamp 9. Check the Relay(Comp.) ON/OFF



The cooling and de-frosting cycle in the process

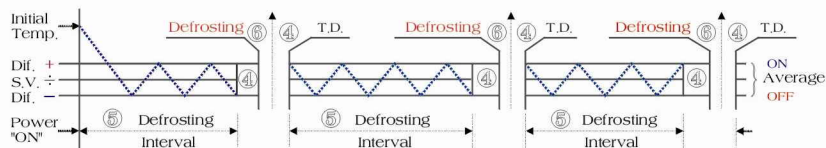

Reference : 1. When the power has been switched off in the process, Whatever modes may have been performing, the defrosting cycle always starts to work from the beginning.

Mod. : Aum-2KND

- The Aum-2KND requires the power supply of 220AC. As soon as the sensor for the temperature and the power is switched on, The present temperature from the sensor will be shown on the display.
- Whenever the "Set" key pressed, a new function it to be selected, but the Ca(Calibration) needs to be pressed by the "Set" key and the "Def" key at the same time.
- Press the "Set" key to select the a function and then, adjust the required value of a direct parameter with the "▲" key or the "▼" one. At last press, the "Set" key again to finalize the selected set value, Otherwise the initial settings of the unit continues to work toward values of the setting.
- Select a function and then adjust a required value of the direct parameter with the "▲" key or the "▼" key consequently a status light of the function will be blinking. It means that the correction is working out now.
- Although either a function has been selected, or the set values has been finalized by the "Set" key, the mode will automatically be returned to a position that the present temperature is shown on the display after 20 seconds.
- In case if manual operation, Press the "Def" key for 5 seconds to start a defrosting function. Furthermore, to stop the manual operation immediately, Press again the "Def" key after 5 seconds. As soon as the defrosting function stops, the system will automatically be returned to the position that the present temperature is shown on the display.
- Right from the moment when the power has been switched on, the defrosting interval repeatedly tracks the setting values of a defrosting function. The actual defrosting time by no means affects the settings of the defrosting interval. In the mean time the "DEF" will be shown on the window for the extended 10 minutes while the defrosting function and the draining function is performing. And also, the mode of the temperature performs as usual during the extended 10 minutes.
- The defrosting mode must be based on an Electric "Heater" or "Hot gas" system.



No.	Status Light	Mode	Working Range	Initial Settings	Unit	Apply	Definition
1.	①	S. V.	-40.0-100.0	5.0	°C	Comp.	S.V. : The value of selection

- Select a function with the "Set" key, and then adjust a required value of direct parameter with the "▲" key or the "▼" one. At last, the "Set" key must be pressed to finalize the new set value that has just been set by the "▲" key or the "▼" one.
- The range of a selected temperature is as follows : $-40.0^{\circ}\text{C} < (\text{S.V.}) + (\text{Dif.}) + (\text{Ca.}) < 100.0^{\circ}\text{C}$.

2.	②	Dif.	$\pm(0.0\sim 12.7)$	$\pm(0.5)$	°C	S. V.	Dif. : Differential (hysteresis)
----	---	------	---------------------	------------	----	-------	----------------------------------

- The working range of a differential simultaneously applies to both set values, which can be sum up with by this way of $(\text{S.V.}) \pm (\text{Dif.})$. For instance, the value of a selected temperature is 5.0°C , and the selected value of a differential is 0.5°C . Eventually the working range of a differential is from 4.5°C to 5.5°C .
- Although the working range of a differential is active from 0.0°C to 12.7°C actually, at least 0.3°C is recommended to protect a mechanical system from an excessive operation.

3.	③	Ca.	$\pm/(0.0\sim 6.3)$	0.0	°C	Sensor	Ca. : Calibration
----	---	-----	---------------------	-----	----	--------	-------------------

- To select the mode of Ca, Press the "Set" key and the "Def" key at the same time.
- The purpose of this function is to correct the differences of present temperature that happens when the led wire of a sensor for the temperature has been extended considerably.
- The extended sensor requires being installed in a long distance, keep it away from a generator or an electrical noise.

4.	④	T. D.	0 ~ 15	00	Minute	Comp.	Time delay+Draining time
----	---	-------	--------	----	--------	-------	--------------------------

- The set value of the "Time Delay" starts immediately to be counted up from the moment as soon as the relay stops working. And then, no function works during the period until the set value of Time Delay is running out.
- The function of the Time Delay protects machines from the damages that can be resulted in by the electrical noise.

5.	⑤	Int.	0 ~ 255	06	Hour	Defrosting Int.	The interval of a defrosting cycle
----	---	------	---------	----	------	-----------------	------------------------------------

- Set the interval values of a defrosting interval with the "Up" key or the "Down" one.
- Set the zero(n-no) as a value of a defrosting interval in case a defrosting mode is a manual.

6.	⑥	Def.	01 ~ 127	30	Minute	Defrosting	Def : The actual defrosting time
----	---	------	----------	----	--------	------------	----------------------------------

- It can be applied to both a manual mode and the an automatic one.
- As soon as the defrosting function is completed automatically, the droplets remaining all around the evaporating sector will be dried out by the performance that is ruled by the set values of a Time Delay.
- No matter what either one of the automatic defrosting function and the manual defrosting function may be working on, press the "Def" key for 3 seconds to stop the defrosting function.

7.	⑦	H / G	Heater/Hot Gas	Heat	Flag	Defrosting	H/G : A method of defrosting
----	---	-------	----------------	------	------	------------	------------------------------

- Press the "▲" key to display the operating mode of "HEAT", and also press the "▼" key to display the operating mode of "Hot".
- The operating mode of the "HEAT" has been chosen, the compressor will be turned off. And then, the defrosting function will start to work. On the contrary, the operating mode of the "Hot" has been set, the defrosting function works. Hence, the compressor will be turned on after 5 seconds.

8.	⑧	I / O	on / off	off	Flag	Comp.	In / Out = ON / OFF
----	---	-------	----------	-----	------	-------	---------------------

- When the led wire of a sensor for the compressor has been disconnected, the light of a fault is lit and immediately the "-LO-" will be shown on the display.
- If it is concerned about a possible happening related to a fault due to the disconnection of a sensor. In that case, You can handle it is advance by letting the compressor work continuously, or by letting it stop.
- To let the compressor continue working on, Press the "▲" key. Otherwise, to let it stop working, Press the "▼" key.

9.	⑨	ON	-	-	-	Comp.	Comp. : Compressor
----	---	----	---	---	---	-------	--------------------

- The light is lit while the compressor is performing.